

Lightwave

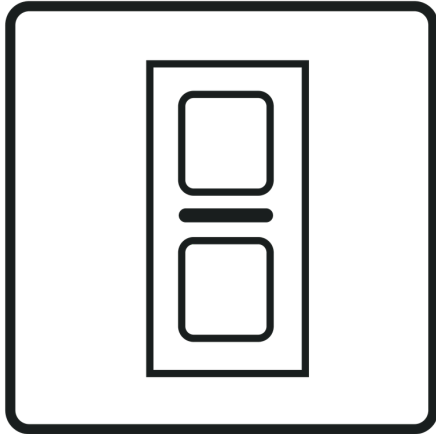

## Installation Manual

EU 1-Gang Smart Series Dimmer  
(Non-UK)  
(LP21EU/LP21WHEU)

# Table Of Contents

Section	Page
Installation Support.....	3
General Information.....	4
Product Dimensions .....	5
Technical Specifications.....	6
Preparing for Installation.....	8
Installing the EU 1-Gang Dimmer Switch.....	9
Wireless Two-way/Intermediate switching .....	11
Wiring Two-way/Intermediate switching .....	13
Creating a Two-Way Switch Automation in the App .....	15
How to pair a EU 1-Gang Dimmer Switch to the Lightwave App.....	17
How to Calibrate the Dimmer Switch.....	19
Creating Automations .....	20
Troubleshooting .....	21
Feedback .....	23

## Installation Support

In this booklet you will find wiring diagrams and instructions on how to set up a EU 1-Gang Dimmer Switch (LP21EU/LP21WHEU).

For further guidance click on the links below:

[Contact the technical support team](#)

[Contact a Lightwave Pro installer](#)

[Have a look at our website](#)

[Phone number: 0121 468 8987](#)

# General Information

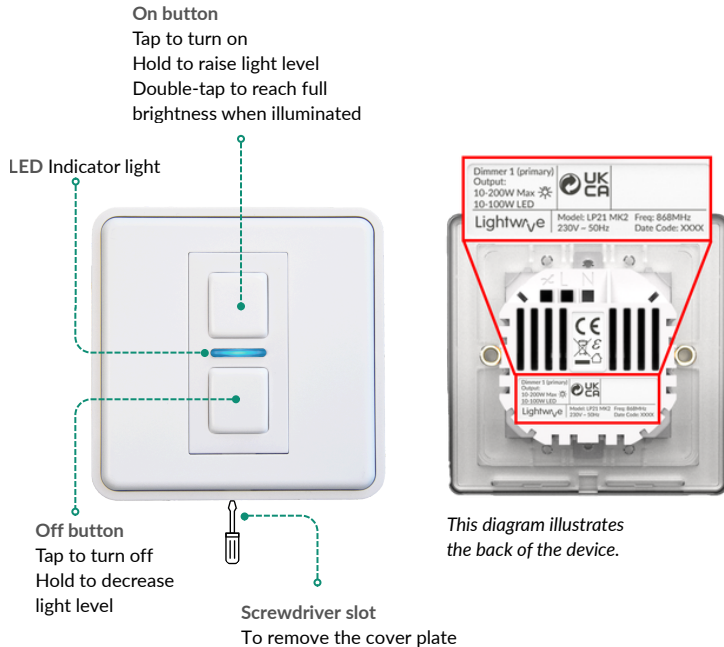

**RF Frequency:**  
868 MHz

**Standby energy use:**  
Less than 1 watt

**Minimum load without a neutral present:**  
10 watts per individual channel

**Minimum load with a Neutral present:**  
5 watts per individual channel

**Is neutral needed?**  
Neutral wire not essential

**Circuit Type:**  
Non-SELV

**Warranty:**  
2-year standard warranty (from the date of purchase).

**Maximum load:**  
100W (LED)  
200W (Incandescent)

A lifetime warranty on the device is available if you are a Lightwave Plus member.

**Earthing requirement:**  
Not essential (double insulated)

## Product Dimensions

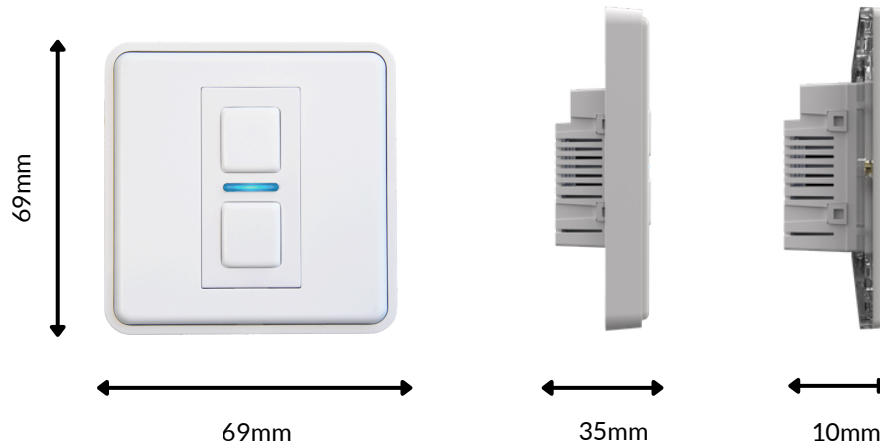

**Height:** 69mm

**Width:** 69mm

**Depth:** 30mm

**Recommended back box size:** EU 1-Gang

**Recommended back box depth (with spacer):** 25mm

**Recommended back box depth (without spacer):** 35mm

# WARNING!

**DAMAGE CAUSED BY INCORRECT LOADING, WIRING OR PHYSICAL DAMAGE WILL INVALIDATE YOUR WARRANTY**

## MAXIMUM LOAD:

- Incandescent lamps: the maximum load is 200 watts per channel, and the minimum is 10 watts per channel.
- GU10/Hi spot Halogen lamps: the maximum is 200 watts per channel, and the minimum is 10 watts per channel.
- LED lamps: the maximum is 100 watts per channel, and the minimum is 10 watts per channel.
- NOT compatible with CFL lamps and electric motors.
- Non-dimmable loads require a neutral wire or a relay.
- LED drivers must be 24-volt output.
- If you've connected the LED strip and driver directly to the dimmer switch, just make sure the total wattage doesn't exceed the dimmer switch's maximum output.
- Please make sure to isolate the mains before you install your Smart Series dimmer switch.

# WARNING!

## PLEASE NOTE:

If operating outside of these parameters, please use a relay (LP81/LP82) or Smart LED Driver ( LP84W100/LP84W200).

For more information, please click on the links below:

- [Smart LED controller - 200 Watts](#)
- [Smart LED controller - 100 Watts](#)
- [Smart relay with open/stop/close - LP82](#)
- [Smart relay with switch sense input - LP81](#)

## CORRECT WIRING:

- This device contains sensitive electronic components. Ensure that wiring is in accordance with manufacturer's instructions.
- Please ensure the power is switched off before wiring your Smart Series dimmer switch, as working on a live circuit can cause the device to fail.
- If in doubt, please contact our technical team, hire a Lightwave Pro installer, or consult a qualified electrician.

# Preparing for Installation

Please follow the electrical wiring instructions carefully to ensure the product is installed safely.

Neglecting to follow these instructions could result in the loss of your 2-year warranty on the device.

**Damage caused by incorrect wiring, any modifications, or physical damage will invalidate your warranty.**

LightwaveRF Technology Ltd cannot accept responsibility for any loss or damage that may occur if the instruction manual is not followed correctly.

**IMPORTANT:** Any electrical installation must comply with building regulations, BS 7671 (IET wiring regulations) or local equivalent.

**IMPORTANT:** If conducting an insulation resistance test, any hard-wired Lightwave devices must be disconnected from the mains, or damage to the unit may occur.

For more information, please click on the links below:

- [Signs of Incompatibility](#)
- [What type of LED Bulbs can I use with my Lightwave Dimmers?](#)

## You will need:

- A back-box with a minimum depth of 35mm (25mm with the included spacer).
  - Suitable electrical screwdrivers.
  - Compatible dimmable lamps/ bulbs.
- (Any lighting that is connected to our dimmer switch must be dimmable)
- Your link Plus Hub and smartphone.
  - The Lightwave Link Plus App can be downloaded. (available on iOS & Android)
  - It is important to isolate the mains before wiring the Smart Series dimmer switch.
  - We recommend capturing photographs of your current wiring setup to assist you in properly installing the dimmer switch.

## What is included in the box:

- Lightwave EU 1-Gang Smart Series Dimmer Switch.
- Installation manual.
- Lightwave spacer.
- 2x terminal screws (standard fixing screws: 30mm).

## Installing a EU 1-Gang Dimmer Switch

If you plan to install this product yourself, please follow the electrical wiring instructions carefully to ensure the product is installed safely, if in any doubt please consult a qualified electrician, technical team or Lightwave Pro installer.

**It is important to install this product in accordance with these instructions. Failure to do so may risk personal safety, create a fire hazard, violate the law and will also void your warranty.**

LightwaveRF Technology Ltd will not be held responsible for any loss or damage resulting from not correctly following the instruction manual.

**PLEASE REMEMBER THAT LIVE ELECTRICITY IS DANGEROUS. DO NOT TAKE ANY RISKS.**

**Turn off the mains electricity:**

It is important to make sure that you turn off the mains power supply to your existing power circuit at the consumer unit.

**Remove the existing switch:**

It's a good idea to take a quick photo of the existing wiring configuration to help you remember which wires connect to which terminals, especially if there are more than two or the labels aren't clear.

Next, unscrew the existing light switch and remove the wires. While the wiring is normally colour-coded and follows the diagram in these instructions, some older installations may not match this standard.

# Installing the EU 1-Gang Dimmer Switch

Be aware that existing cables can vary in colour and may not always be correctly labelled. If in any doubt, always consult a qualified electrician or hire a Lightwave Pro installer. To reattach the faceplate, align it with the top of the dimmer and press down gently until it clicks into place. Please check the wiring and load, ensuring it does not exceed the maximum wattage 100W (LED) or 200W (Incandescent) per channel and only use recommended dimmable lights.

## One way wiring:

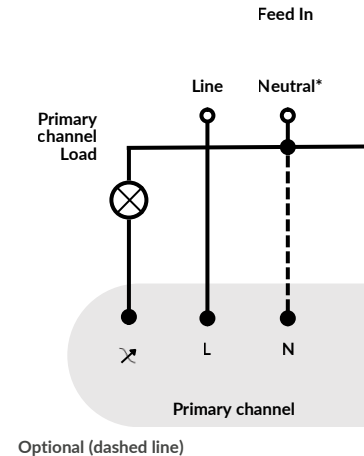
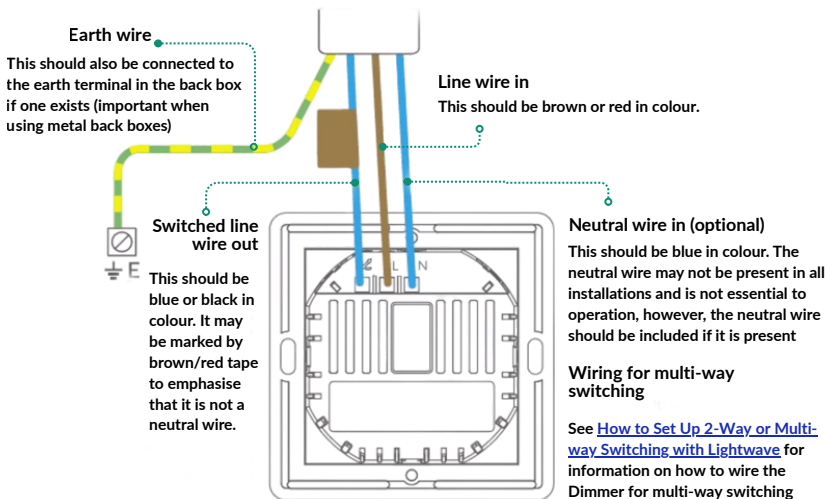

For more information, please click on the link: [Installation video of how to install a smart series dimmer switch](#)

# Wireless Two-way/ Intermediate Switching

Wireless Multi-way Switching is when one dimmer is physically wired (the “master”), and all others operate wirelessly by the Lightwave App through a two-way switch automation. (This works without internet connectivity)

Be aware that existing cables can vary in colour and may not always be correctly labelled. If in any doubt, always consult a qualified electrician or hire a Lightwave Pro installer. To reattach the faceplate, align it with the top of the dimmer and press down gently until it clicks into place. Please check the wiring and load, ensuring it does not exceed the maximum wattage 100W (LED) or 200W (Incandescent) per channel and only use recommended dimmable lights.

## Follow these 3 steps to do Wireless Two-way Switching:

### 1. Wiring the Master Dimmer (1-Way)

- Wire one dimmer as the 1-way master (only unit connected to the lighting circuit).
- Live → L, Neutral → N, Switch Live → X.
- The neutral wire is optional for this wireless two-way switching.
- See Page 9-10 for the full wiring diagram.
- The master receives Live + Switched Live and controls the actual lighting load.

### 2. Wiring Secondary / Slave Dimmers

- Secondary dimmers do not connect to the lighting circuit; they must have constant power for wireless operation.

# Wireless Two-way/ Intermediate Switching

## Using 2-, 3-, or 4-Gang Secondary Dimmers

- Terminate off all 3-core cables, as they are not used in wireless switching.
- Any channel can be used for wireless two-way switching, and the right-hand (primary) channel can do so if Neutral is present by connecting Live to L, Neutral to N, and disconnecting the switch live wire. If no neutral wire is present, wireless two-way switching must be done using the far left channel of the dimmer switch.

## Using a 1-Gang Secondary Dimmer

- Supply with permanent Live + Neutral.
- Terminate off the Switched Live—unused in wireless mode.
- Ensure the dimmer receives constant, uninterrupted power.

## 3. Enabling Wireless Control

- After wiring, only the master will control the light.
- Pair all dimmers in the Lightwave app.
- Create a 2-way switch automation linking each secondary dimmer to the master.
- See Pages 15–17 for detailed pairing and automation steps.

### Successful setup Indicators:

- Secondary/slave dimmers show an “S” in the app and operate wirelessly.
- Secondary/slave dimmers can only be controlled manually, not from the app.
- You can add unlimited secondary switches to the setup.

For more information, please click on the link below:

[How to Set Up 2-Way or Multiway Switching with Lightwave](#)

# Wiring Two-way/ Intermediate Switching

Be aware that existing cables can vary in colour and may not always be correctly labelled. If in any doubt, always consult a qualified electrician or hire a Lightwave Pro installer. To reattach the faceplate, align it with the top of the dimmer and press down gently until it clicks into place. Please check the wiring and load, ensuring it does not exceed the maximum wattage 100W (LED) or 200W (Incandescent) per channel and only use recommended dimmable lights.

**Each additional dimmer in the circuit increases the minimum load by 10W—for example, two dimmers require a 20W minimum load.**

## Two-way switching:

### Follow these steps to wire both dimmer switches:

- Move all wires from L1 to the L terminal on the Lightwave switch.
- Move wires from L2 to the X terminal.
- Wires in the C terminal aren't needed—either remove them or terminate safely.
- If you have a neutral wire, then please connect to the N terminal.

For more information, please click on the link below:

[How to Set Up 2-Way or Multiway Switching with Lightwave](#)

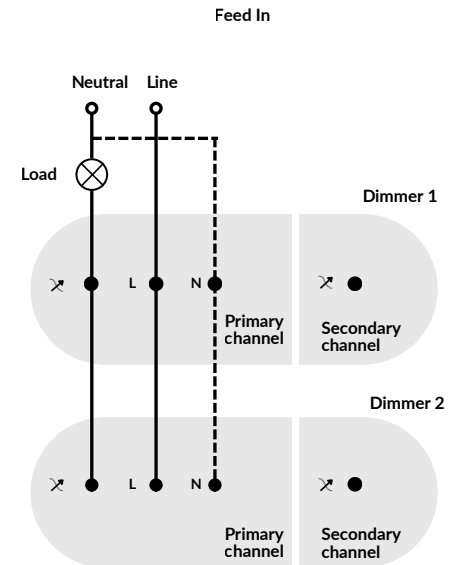

Optional (dashed line)

# Wiring Two-way/ Intermediate Switching

Be aware that existing cables can vary in colour and may not always be correctly labelled. If in any doubt, always consult a qualified electrician or hire a Lightwave Pro installer. To reattach the faceplate, align it with the top of the dimmer and press down gently until it clicks into place. Please check the wiring and load, ensuring it does not exceed the maximum wattage 100W (LED) or 200W (Incandescent) per channel and only use recommended dimmable lights.

**Each additional dimmer in the circuit increases the minimum load by 10W—for example, two dimmers require a 20W minimum load.**

## Intermediate wiring:

These steps follow standard two-way wiring, but with a special middle (intermediate) switch that has extra wiring.

You can spot it easily—it has two sets of L1 and L2 terminals on the back.

## Follow these steps to wire up the middle (intermediate) switch:

- Move one set of L1 and L2 wires to the L terminal on the Lightwave Switch.
- Connect the other set of L1 and L2 wires to the X terminal.

For more information, please click on the link below:

[How to Set Up 2-Way or Multiway Switching with Lightwave](#)

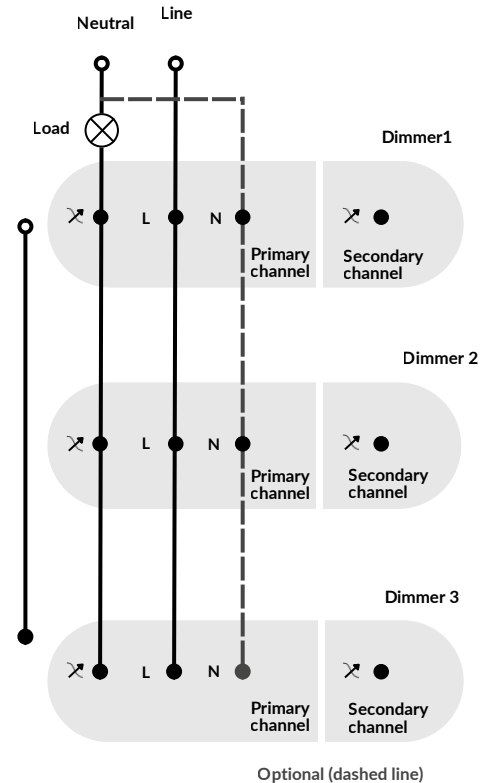

# Creating a Two-Way Switch Automation in the App

**Please note: You will follow these steps even if there is 2 or more dimmer switches in the two-way/intermediate switching.**

After wiring the setup, only the master switch will control the light(s) at first. So, you will need to pair all dimmer switches with the Lightwave Link Plus App. Once paired, create a two-way switch automation in the app so all dimmer switches can control the light(s).

## How to create a two-way switch automation in the Lightwave Link Plus App:

- Open the app and tap the green plus (+) button at the bottom.
- Select the Automations icon.
- Tap "Two-way switching" (look for the stairs icon).
- Choose the dimmer switches from the list of rooms and tap "Next" (top right).
- Select the master dimmer (the one that controls the lights directly), then tap "Next" again. The other dimmers will automatically be set as secondary switches.

Note: Secondary switches can only be used manually—not via the app.

- Enter a name for the automation in the grey box that says e.g. landing lights, then tap "Done" (top right).
- The master dimmer will run through a calibration process.

**You've now successfully set up two-way switching!**

# Creating a Two-Way Switch Automation in the App

For more information, please click on the links below:

- [What is dimming profile and how does it work?](#)
- [How to create a 2-WAY Switching Automation on the Lightwave Link Plus App?](#)

## Extra information:

- If the master dimmer doesn't output light, try adjusting the dimming profile or calibrate the channel in the app.
- If the master dimmer doesn't output light, double check that the dimmer is not set as a slave in the two way switch automation.
- Once set up, you can manually turn lights on/off or dim them from any dimmer in the automation.
- Slave dimmers (marked with an "S" in the Lightwave Link Plus App) are for physical use only.
- When used, their LED will briefly flash green, showing they're set as a secondary switch.

# How to pair a EU 1-Gang Dimmer Switch to the Lightwave App

**Before you begin:** Download the Lightwave Link Plus App from the Google Play Store or Apple App Store.

**Adding a smart series device to the Lightwave Link Plus App:**

**Before you start,** ensure the Link Plus Hub is positioned high and centrally in the house for the best signal.

- Open the app and tap the green plus (+) button at the bottom of the page. Then select the Devices icon.
- Enter a name for your device in the grey box, for example Porch Spotlights.
- Put the device into pairing mode (see below). While the device LED is flashing red and blue, tap Link in the app.
- The app will scan and pair with the device. Once linked, the LED will flash blue rapidly.
- After adding the device, assign it to a room in the app to make it easier to control and organise your devices.







**Pairing mode:**

- Press and hold the top and bottom button for 5 seconds until the LED flashes red and blue.

**Issue with pairing the device:**

- If the device exits pairing mode too soon, repeat the button press to re-enter pairing mode.
- If the LED flashes red only, the device's memory must be cleared with a master reset. (see below)

## LED Indicator Lights

-  → Dimmer is On
-  → Pairing Mode
-  → Successful Pairing
-  → Memory is Full
-  → Dimmer is Off
-  → Dimmer is Locked
-  → Dimmer is updating

# How to pair a EU 1-Gang Dimmer Switch to the Lightwave App







## How to master reset the device:

- Press and hold both the top and bottom button until the dimmer flashes red.
- Release both buttons, then press and hold the bottom button until the dimmer flashes red rapidly.
- Release the bottom button— the LED will turn green and white as it calibrates. When it turns solid red, the dimmer is ready to pair again.

## For more information, please click on the links below:

- [How to add devices to the Link Plus App?](#)
- [How to put your devices into pairing mode?](#)
- [How do I master reset Lightwave devices?](#)
- [What do the LED colours indicate on the front of the device?](#)
- [How to change or turn off the led indicator light on a Lightwave device](#)

### LED Indicator Lights

-  → Dimmer is On
-  → Pairing Mode
-  → Successful Pairing
-  → Memory is Full
-  → Dimmer is Off
-  → Dimmer is Locked
-  → Dimmer is updating

# How to Calibrate the Dimmer Switch

## What is Calibration?

After the dimmer is installed, with lamps connected and power switched on, it will automatically enter calibration mode. This process sets the best dimming range for your lamps to ensure compatibility.

*Note: Calibration only runs on the Primary channel (Channel 1 – the first on the right-hand side).*

## Automatic Calibration:

After wiring the dimmer, Channel 1 (the first channel on the right) will automatically begin calibration 5 seconds after power is switched on.

- The channel may light up green and white to show that it is calibrating.
- To start a new calibration (recommended if you've changed the lamps), press the ON button within 5 seconds.

## Manual Calibration through the Lightwave Link Plus App:

**This is important for the non-primary channels (channel 2-4 on the left-hand side).**

Manual calibration is used to fine-tune the dimming range—especially helpful if:

- Lights flicker or behave unpredictably at very low or high brightness levels.
- You're using lamps that aren't fully compatible.
- Each channel can be manually calibrated through the app.
- During auto calibration, the LEDs will flash green.

Example: If your LED bulbs flicker at full brightness (100%), you can set a custom dimming range—such as 0% to 80%—to prevent flickering and improve stability.

For more information, please click on the link: [How to Calibrate Your Lightwave Dimmer for Optimal Performance](#)

# Creating Automations

- Using the Link Plus and Lightwave App, you can create custom automations for the dimmer switch.
- As long as the Link Plus Hub is still connected to power, your automations will continue to work even if you lose your internet connection.
- You need internet connection to create the automations.

## Types of automations you can create with a dimmer switch:



**Timer =** When you would like a device to operate at a set time and on certain days.



**Schedule =** It is recommended to use a schedule when you would like a device to operate certain times throughout the week and on specific days.



**If-Do =** This automation triggers another action. For example: when one light switches on, all lights in the house turn on.



**Group =** This can be used to make multiple devices 'copy' each other. Useful for controlling many devices in the same location by only interacting with one of them.



**Do =** Can be used to create moods/scenes. It works on-demand only, so requires execution via the Link Plus App or via Google Home, Apple Home or Alexa.



**Simulated Occupancy =** This can be used to schedule your lights to come on at random times throughout the day when you are not at home.



**Two-way switching =** This can be used to make multiple dimmer switches mirror each other. This is commonly used with one switch at the top of the stairs and one at the bottom of the stairs.



**Multi-press =** Gives you the option to trigger an automation to work from a single, multiple, long & release presses.

For more information, please click on the link: [Introduction to Automations](#)

# Troubleshooting

If your Lightwave dimmer switch isn't behaving as expected, the steps below cover the most common issues and how to resolve them.

## 🔧 Device not linking to the app

- Check the device hasn't been added to the default room (if no room is selected, it goes to the top room on your rooms list automatically).
- Make sure the device is within close range of the Link Plus hub.
- If the LED flashes red when pairing, the device memory is full and will need clearing before it can be added.

Helpful Guides:

[Why Won't My Devices Pair to the Link Plus App?](#)

[Where is the best place to position my Link Plus Hub?](#)

## ● Flashing red LED light when pairing

A flashing red LED means the device memory is full, usually after a failed pairing attempt.

To clear the memory:

- Press and hold the top and bottom buttons until the LED flashes red.
- Release both buttons, then press and hold the bottom button until the LED flashes red rapidly.
- Release — the Dimmer will calibrate and flash between green/white, then turn solid red when ready to pair again.

Helpful Guides:

[How do I master reset Lightwave devices?](#)

[Why does my dimmer flash red when I put it into pairing mode?](#)

# Troubleshooting

If your Lightwave dimmer switch isn't behaving as expected, the steps below cover the most common issues and how to resolve them.

 **Lights flickering** = This is usually caused by incompatible bulbs, incorrect load, or calibration issues.

What to try:

- Ensure bulbs are compatible and dimmable.
- Confirm the total load is within limits (100W and 15 Bulbs LED MAX PER GANG)
- Run calibration in the Lightwave app.

Helpful Guides:

[Why are my lights flickering, and how can I fix it?](#)

 **Green & purple flashing** = This means auto-calibration has failed.

What to try:

- Make sure that you're using dimmable bulbs with over 10W of load on the circuit.
- If available, connect a Neutral wire.
- Run calibration again on the Lightwave app after making changes.

Helpful Guides:

[How to Calibrate Your Lightwave Dimmer for Optimal Performance](#)

 **Linked but not working** = If the device appears in the app but doesn't respond, it may be paired as a Connect Series device.

What to try:

- Delete the device from the app.
- Clear the memory of the device.
- Put it back into pairing mode.
- Re-add it as a Smart Series device.

Helpful Guides:

[How to put your devices into pairing mode?](#)

[How to delete a device from the Lightwave Link Plus app?](#)

[How to add devices to the Link Plus App](#)

## Feedback



**We've just launched our new Lightwave installation manuals and would love to hear what you think!**

**Your feedback helps us improve our guides and provide better support, whether it's something you liked or something we could make clearer. It only takes a few minutes and really makes a difference.**

**[Please click here to share your feedback](#)**

Thank you for helping us improve your Lightwave experience.