

Lightwave

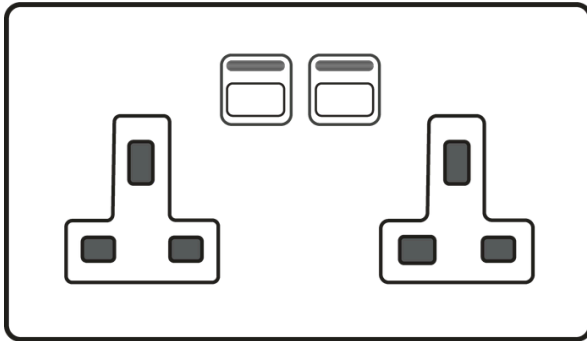

Installation Manual

2-Gang Smart Series Socket
(LP42/LP42WH)

Table Of Contents

Section	Page
Installation support.....	3
General Information.....	4
Product Dimensions.....	5
Technical Specifications.....	6
Preparing for Installation.....	7
Installing a 2-Gang Smart Socket	8
How to pair a 2-Gang Smart Socket to the Lightwave Link Plus App	10
Creating Automations	12
Energy Monitoring on the Lightwave Link Plus App	13
Troubleshooting	14
Feedback	16

Installation Support

In this booklet you will find wiring diagrams and instructions on how to set up a 2-Gang Socket (LP42/LP42WH).

For further guidance click on the links below:

[Contact the technical support team](#)

[Have a look at our website](#)

[Contact a Lightwave Pro installer](#)

[Phone number: 0121 468 8987](#)

General Information

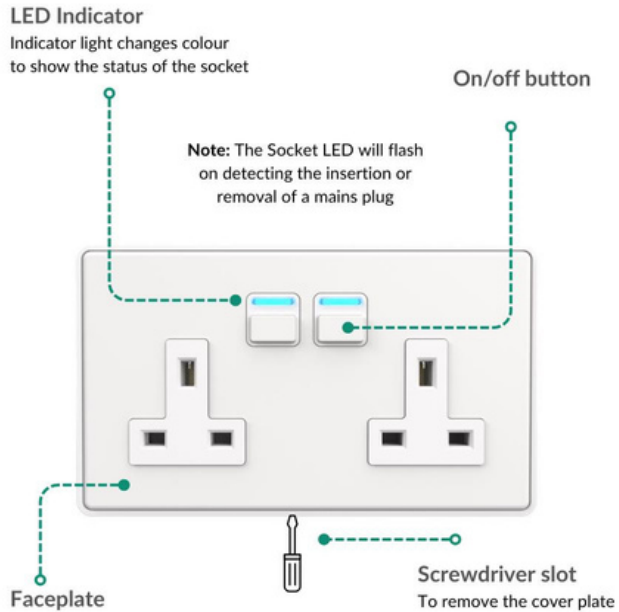

RF Frequency:
868 MHz

Voltage and Frequency:
230V ~ 50Hz

Current: 13 A

Standby energy use:
Less than 1 watt

Warranty:
2 years standard warranty (from the date of purchase).

A lifetime warranty on the device is available if you are a Lightwave Plus member.

Link plus hub:
Make sure that the Link Plus hub is in a high and central location for optimal communication.

Product Dimensions

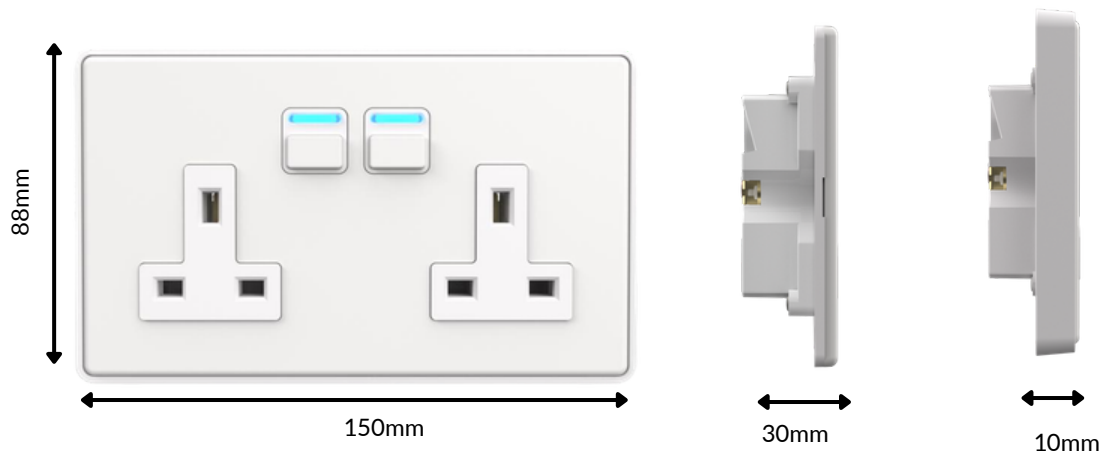

Height: 88mm

Width: 150mm

Depth: 30mm

Recommended back box size: UK standard 2-Gang

Recommended back box depth (with spacer): 25mm

Recommended back box depth (without spacer): 35mm

WARNING!

DAMAGE CAUSED BY INCORRECT LOADING, WIRING OR PHYSICAL DAMAGE WILL INVALIDATE YOUR WARRANTY

Please Note:

- Please make sure to isolate the mains before you install your 2-Gang Smart Socket
- This device contains sensitive electronic components, ensure that wiring is in accordance with manufacturer's instructions.
- Please make sure to not wire up your socket live as it will cause the 2-Gang Smart Socket to fail.
- If in doubt, please contact our technical team, hire a Lightwave Pro installer, or consult a qualified electrician.

Preparing for Installation

Please follow the electrical wiring instructions carefully to ensure the product is installed safely.

Neglecting to follow these instructions could result in the loss of your 2-year warranty on the device.

Damage caused by incorrect wiring, any modifications or physical damage will invalidate your warranty.

LightwaveRF Technology Ltd cannot accept responsibility for any loss or damage that may occur if the instruction manual is not followed correctly.

IMPORTANT: Any electrical installation must comply with building regulations, BS 7671 (IET wiring regulations) or local equivalent.

IMPORTANT: If conducting an insulation resistance test, any hard-wired Lightwave devices must be disconnected from the mains, or damage to the unit may occur.

You will need:

- A back-box with a minimum depth of 35mm (25mm with included spacer)
- You will need suitable electrical screwdrivers
- Your Link Plus Hub and smartphone
- The Lightwave Link Plus App can be downloaded (available on iOS & Android)
- It is important to isolate the mains before wiring the smart series 2-Gang Socket
- We recommend capturing photographs of your current wiring setup to assist you in properly installing the 2-Gang smart socket.

What is included in the box:

- Lightwave Smart Series 2-Gang Socket
- Installation manual
- Lightwave spacer
- 2x terminal screws (standard fixing screws: 30mm)

Installing a 2-Gang Smart Socket

If you plan to install this product yourself, please follow the electrical wiring instructions carefully to ensure the product is installed safely, if in any doubt please consult a qualified electrician, technical team or Lightwave Pro installer.

It is important to install this product in accordance with these instructions.

Failure to do so may risk personal safety, create a fire hazard, violate the law and will also void your warranty. LightwaveRF Technology Ltd will not be held responsible for any loss or damage resulting from not correctly following the instruction manual.

PLEASE REMEMBER THAT LIVE ELECTRICITY IS DANGEROUS. DO NOT TAKE ANY RISKS.

Turn off the mains electricity:

It is important to make sure that you turn off the mains power supply to your existing power circuit at the consumer unit.

Remove the existing switch:

It's a good idea to take a quick photo of the existing wiring configuration to help you remember which wires connect to which terminals, especially if there are more than two or the labels aren't clear.

Next, unscrew the existing socket and remove the wires. While the wiring is normally colour-coded and follows the diagram in these instructions, some older installations may not match this standard.

Installing a 2-Gang Smart Socket

Be aware that existing cables can vary in colour and may not always be correctly labelled. If in any doubt, always consult a qualified electrician or hire a Lightwave Pro installer. Remove the faceplate from the Lightwave socket by inserting a screwdriver into the small bottom slot, and reattach by aligning it at the top and pressing down until it clicks into place.

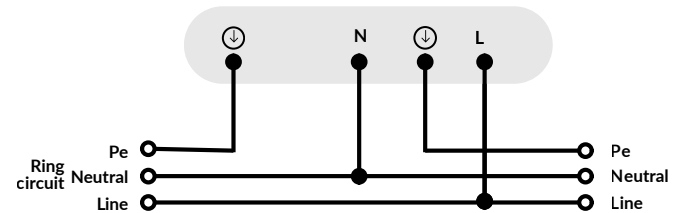
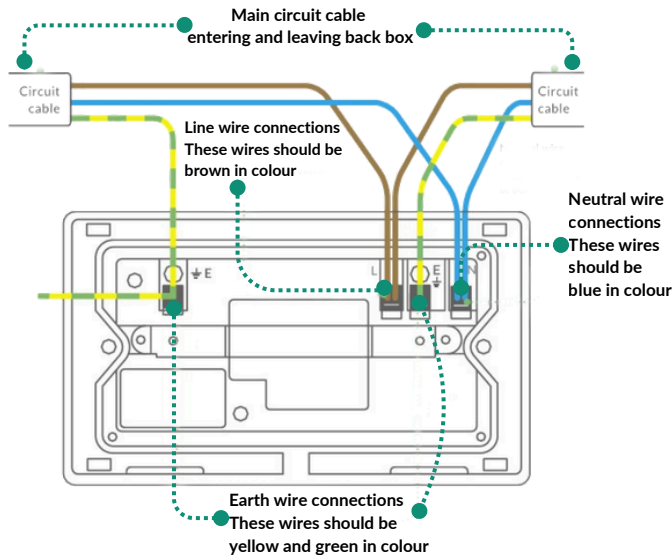

For more information, please click on the link: [Installation video of how to install a smart series 2-gang socket](#)

How to pair a 2-Gang Smart Socket to the Lightwave Link Plus App

Before you begin: Download the Lightwave Link Plus App from the Google Play Store or Apple App Store.

Adding a Smart Series device to the Lightwave Link Plus App:

Before you start, ensure the Link Plus Hub is positioned high and centrally in the house for the best signal.

- Open the app and tap the green plus (+) button at the bottom of the page. Then select the Devices icon.
- Enter a name for your device in the grey box, for example Porch Spotlights.

PLEASE NOTE: Both channels on the socket will pair to the app automatically, so you do not need to pair each channel individually.

For example, if you name a 2 gang socket TV, the app will automatically discover all 2 channels. In the app, the channels will be displayed as TV 1 and 2. You can then rename them as needed after they have been added to a room.

- Put the device into pairing mode (see below). While the device LED is flashing red and blue, tap Link in the app.
- The app will scan and pair with the device. Once linked, the LED will flash blue rapidly.
- After adding the device, assign it to a room in the app to make it easier to control and organise your devices.







Pairing mode:

- Press and hold either button for 5 seconds until the LED flashes red and blue.

Issue with pairing the device:

- If the memory is full, the socket will flash purple when you press and hold it. If the socket exits pairing mode too soon, press and hold the button again to re enter. If the LED only flashes red, the device memory needs to be cleared. (see below)

LED Indicator Lights

-  → Socket is ON
-  → Pairing Mode
-  → Successful Pairing
-  → Memory is Full
-  → Socket is Off
-  → Socket is Locked
-  → Socket is updating

How to pair a 2-Gang Smart Socket to the Lightwave Link Plus App

How to master reset the device:

- Press and hold a button until the LED flashes red, then release.
- Press and hold the same button again for 20 seconds until the LED flashes red rapidly, then release.
- The LED will turn green and then change to solid red, indicating that the socket is ready to be paired again with the Link Plus App

PLEASE NOTE:

When performing a master reset on the 2 Gang Smart Series Socket, the memory will be cleared across all 2 channels automatically. There is no need to reset each channel individually.

[For more information, please click on the links below:](#)

[How to add devices to the Link Plus App?](#)







[How to put your devices into pairing mode?](#)

[How do I master reset Lightwave devices?](#)

[What do the LED colours indicate on the front of the device?](#)

[How to fix a smart socket that isn't updating](#)

LED Indicator Lights

-  → Socket is ON
-  → Pairing Mode
-  → Successful Pairing
-  → Memory is Full
-  → Socket is Off
-  → Socket is Locked
-  → Socket is updating

Creating Automations

Putting the Smart Socket into locking mode:

To lock / unlock the Smart Socket, press the 'lock' button on the Lightwave App. This means that the manual button will not operate it. A locked Smart Socket is signified by a slow flashing purple LED when the manual button is pressed.

- Using the Link Plus and Lightwave App, you can create custom automations for the 2-gang smart socket.
- As long as the Link Plus Hub is still connected to power, your automations will continue to work even if you lose your internet connection.
- You need internet connection to create the automations.

Types of automations you can create with a Smart Series 2 Gang Socket:



Timer = When you would like a device to operate at a set time and on certain days.



Schedule = It is recommended to use a schedule when you would like a device to operate certain times throughout the week and on specific days.



If-Do = This automation triggers another action. For example: when one light switches on, all lights in the house turn on.



Group = This can be used to make multiple devices 'copy' each other. Useful for controlling many devices in the same location by only interacting with one of them.



Do = Can be used to create moods/scenes. It works on-demand only, so requires execution via the Link Plus App or via Google Home, Apple Home or Alexa.



Simulated Occupancy = This can be used to schedule your lights to come on at random times throughout the day when you are not at home.



Multi-press = Gives you the option to trigger an automation to work from a single, multiple, long & release presses.

For more information, please click on the link: [Introduction to Automations](#)

Energy Monitoring on the Lightwave Link Plus App

- You can monitor your energy usage on any device connected to the Lightwave Link Plus App.
- For example, you can monitor heating devices, smart sockets, dimmer switches, and more.
- This information will assist you in effectively reducing your energy consumption, enabling you to lower your electricity expenses.
- To save energy, we recommend adding the devices that consume the most power to automations.
- For example, you can put the heating on a schedule throughout the day during winter to help you save money.
- Another example is setting straighteners on a timer so that, if you forget to turn them off, the plug will automatically switch off after a set time.

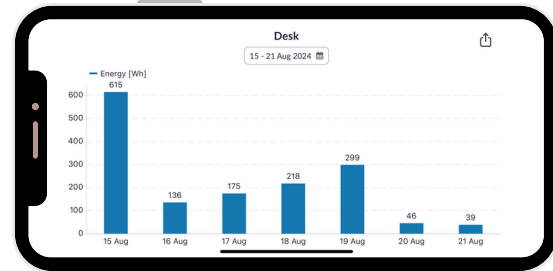

How accurate is the energy monitoring?

Updates from the energy monitor occur as frequently as every 15 seconds. However, we intentionally restrict the data sent to the server based on current and total values to minimize unnecessary duplication of data. Your live current usage will generally be within 10% of the value displayed when you're away, and the total usage will differ by no more than 0.1kWh. The total usage recorded for yesterday reflects the highest measured value transmitted to the server during that period.

[For more information, please click on the link: Understanding Energy & Cost Monitoring in the Lightwave App](#)

Troubleshooting

If your Lightwave Outdoor Smart Socket isn't behaving as expected, the steps below cover the most common issues and how to resolve them.

⚠️ **Linked but not working**

If the device appears in the app but doesn't respond, it may be paired as a Connect Series (Generation 1) device.

What to try:

- Delete the device from the app.
- Clear the memory of the device.
- Put it back into pairing mode.
- Re-add it as a Smart Series device using the name box at the top of the linking screen rather than using "link connect series device"

Helpful Guides:

[How to put your devices into pairing mode?](#)

[How to delete a device from the Lightwave Link Plus app?](#)

[How to add devices to the Link Plus App](#)

🔌 **Device not linking to the app**

- Check the device hasn't been added to the default room (if no room is selected, it goes to the first room automatically).
- Make sure the device is within close range of the Link Plus hub.
- If the LED flashes red when pairing, the device memory is full and will need clearing before it can be added.

Helpful Guides:

[Why Won't My Devices Pair to the Link Plus App?](#)

[Where is the best place to position my Link Plus Hub?](#)

Troubleshooting

If your Lightwave Outdoor Smart Socket isn't behaving as expected, the steps below cover the most common issues and how to resolve them.

● Flashing red LED light when linking

A flashing red LED means the device memory is full, usually after a failed pairing attempt.

To master reset the device:

- Press and hold a button until the LED flashes red, then release.
- Press and hold the same button again until the LED flashes red rapidly, then release.
- The LED will turn green and then change to solid red, confirming the socket is ready to be paired again with the Link Plus app.

Helpful Guides:

[How do I master reset Lightwave devices?](#)

🔄 Device appears not to be updating

If both buttons on the socket are pressed during linking, the device may incorrectly show that an update is required when no update is needed. The device will also display “error sending command” when you use the app to control it.

How to resolve this:

- Delete the Smart Socket from the Lightwave App
- Clear the memory of the Smart Socket
- Re-pair the socket, pressing only one button during setup.

This should allow the installation to complete successfully.

Helpful Guides:

[How to Fix a Smart Socket That Isn't Updating](#)

Feedback



We've just launched our new Lightwave installation manuals and would love to hear what you think!

Your feedback helps us improve our guides and provide better support, whether it's something you liked or something we could make clearer. It only takes a few minutes and really makes a difference.

[Please click here to share your feedback](#)

Thank you for helping us improve your Lightwave experience.